



INSTALLATION INSTRUCTIONS

512-0105

CHEVROLET SILVERADO AND GMC SIERRA 1500

2019+

ENGINE: 5.3L

FILTER CF-7540

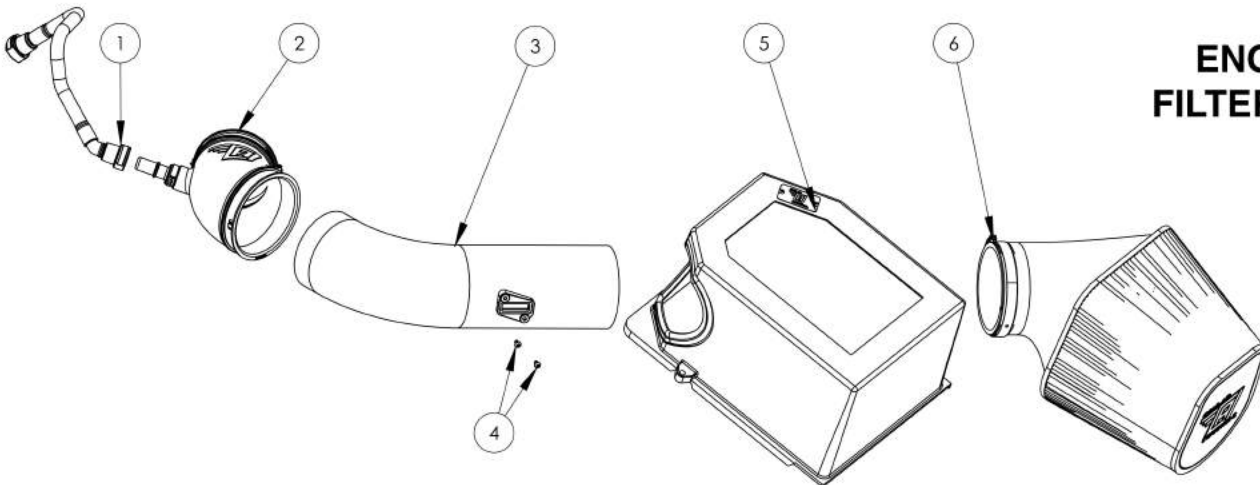

ITEM NO.	PART NUMBER	DESCRIPTION	QTY.
1	PCV-0001	PCV/TUBE	1
2	ITR-0001-ASM	INLET/DUCT	1
3	ITA-0026-70B	MAF/TUBE	1
4	FTN-0001-BCM	M4-0.7 x 8mm S.S. BUTTON HEAD CAP SCREW	2
5	BOX-0028-70B	AIR INDUCTION HOUSING	1
6	CF-7540	FILTER ELEMENT-A/CL	1

TOOLS NEEDED:

- Ratchet
- Extension
- 8mm socket
- 10mm socket
- 2.5mm allen wrench
- 5/16 nut driver
- T20 torx

If you need any assistance, **PLEASE VISIT OUR WEBSITE WWW.COLDAIRINDUCTIONS.COM TO VIEW THE INSTALL VIDEO** or call 1-810-392-9999 to speak with a customer service representative.

NOTE: FAILURE TO FOLLOW INSTALLATION INSTRUCTIONS AND NOT USING THE PROVIDED HARDWARE MAY DAMAGE THE AIR INDUCTION SYSTEM, THROTTLE BODY AND ENGINE.

REMOVAL OF OEM SYSTEM



1. Turn off the ignition. Let the engine cool before installation.



2. Disconnect the negative battery cable with the 10mm socket and ratchet.



3. Disconnect PCV fitting from valve cover.



4. Loosen clamp on throttle body and air cleaner assembly.



5. Remove wire tie.

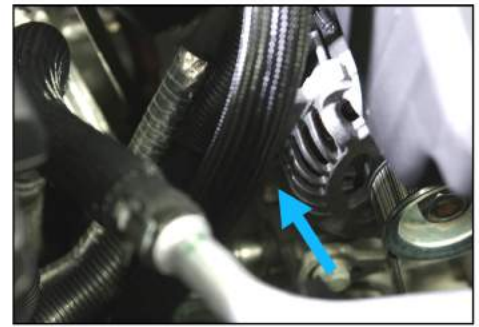

6. Remove the bolt and bracket attaching the OUTLET/DUCT assembly to the alternator with the 10mm socket and ratchet.



7. Remove OUTLET/DUCT from vehicle.



8. Disconnect the wire harness from the MAF sensor.



9. Remove the OEM COVER using the ratchet, 8mm socket and extension. Remove all three screws.

INSTALLATION OF NEW CAI SYSTEM



10. Remove AIR INDUCTION HOUSING COVER and air filter. Place the factory AIR INDUCTION HOUSING on work bench.



11. Remove the MAF sensor using a T20 torx by removing the two screws holding it in place on the MAF/TUBE. NOTE: Carefully handle the MAF sensor.



12. Remove both screws on the MAF/TUBE with 2.5mm allen wrench.

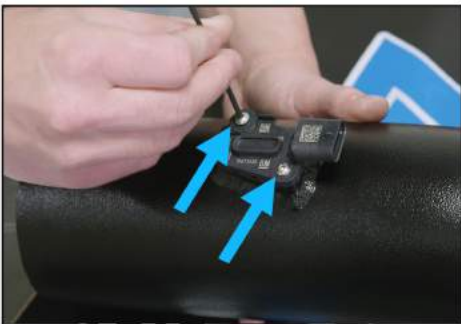

13. Install MAF sensor into MAF/TUBE, replace 2 button head screws. Tighten 2.5-foot pounds.

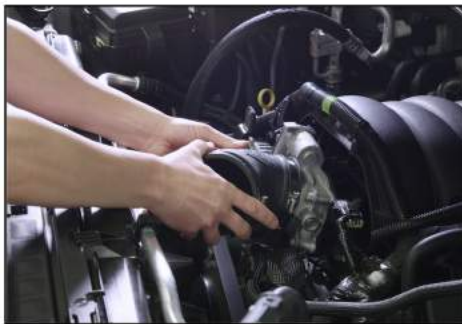

14. Install INLET/DUCT onto throttle body. Leave all connections loose.



15. Reconnect PCV tube.



16. Insert FILTER ELEMENT into AIR INDUCTION HOUSING.

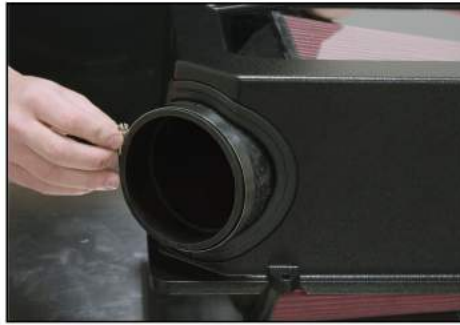

17. Install clamp onto the FILTER ELEMENT.



18. Install the MAF/TUBE into filter. Seat completely.



19. Align dot on MAF/TUBE to emboss on FILTER ELEMENT.

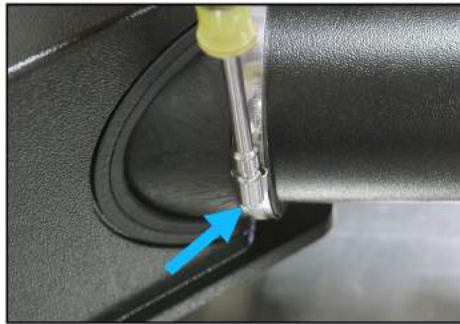

20. Tighten hose clamp on FILTER ELEMENT with 5/16 nut driver.



21. Install AIR INDUCTION HOUSING into the vehicle.



22. Replace the 3 screws into the AIR INDUCTION HOUSING, using the ratchet, 8mm socket and extension.

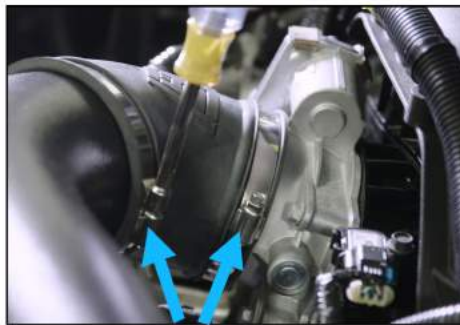

23. Orientate MAF/TUBE correctly and tighten both hose clamps with 5/16 nut driver.



24. Reroute A/C wire under A/C hose and connect.



25. Reconnect negative battery terminal with 10mm socket and ratchet.



26. Slowly lower your hood and check for clearance.
27. Time for a test drive.

*****IMPORTANT*****

Warranty Registration Instructions

***This product comes with a Limited Lifetime Warranty against material defects and product craftsmanship. The intake kit must be registered online for your warranty to be activated. To register your product go to:

www.coldairinductions.com/contact-us/register



NOTE: NOT LEGAL FOR SALE OR USE IN STATE OF CALIFORNIA



Cold Air Inductions Inc. 717 Burnell Rd. Memphis, MI 48041
Phone: 810-392-9999 Monday-Friday 8:00 am to 4:30 pm EST
Web: coldairinductions.com Email: support@coldairinductions.com
